



0845 223 2124



uniononline.co.uk

UNION

ASSA ABLOY

JIGTECH™

Fast fitting door handle
and latch system



Performance you can trust

What does the **trade** think?

- // I have been in the industry for 12 years and your product is genuinely revolutionary. I will be using Jigtech from now on across all my sites.
- // **Topline. Worth it. Overall by far the best way to go I have found. The handles are very good quality. Best I could find. Heavy and looks great. It will save you time but more importantly stress and will give an excellent result.**
- // What an amazing kit, absolute game-changer, I will only install doors using this now. Thank you.
- // **We used the Jigtech system for all the doors in our new build and it was brilliant, saved loads of time and perfectly fitted on every door, quality of handles was excellent. Highly recommended.**
- // Really does make fitting doors a pleasure - quick, easy, professional and a great end result.

Contents

6	Jigtech PRO kit
8	Premium handles
14	Contract handles
20	Switch handles
22	Latches and bolts
24	Accessories



**Fits in under five minutes
Simple to use
Accurate and precise**

JIGTECH™

Jigtech is a revolutionary door handle and latch fitting system which reduces fitting time and improves efficiency and accuracy by changing the way you install door furniture and latches.

Jigtech has created a new standard in door hardware installation with the innovative system reducing fitting time from over 25 minutes to under 5 minutes. This results in a time saving of 80% benefitting both contractors and fitters alike with increased efficiency and functionality.



- **Fit handles in under five minutes**
- **Accurate and precise**
- **Saves time and money**
- **Easy to install**
- **Fire rated and Certifire approved handles**

- Unique finishes
- Door packs available
- Wide variety of handles
- Range of finishes including polished chrome, satin chrome, black nickel and antique brass



To complement the fitting system we also offer a range of stylish handles, latches in modern finishes, alongside several accessories designed specifically for the innovative fitting system.

Kits compatible with:

- Contract and premium handles
- Up to 54mm thick doors
- CE SmartLatch and CE SmartBolt
- Push button privacy



How to achieve fire-rating

An extension fixing pack and 34mm spade bit will be required for 54mm thick doors. The premium handles must be installed with CE SmartLatch and an intumescent kit to be fully compliant for fire doors up to FD60.

Applications

Whether you need a striking, contemporary style for a new home or apartment, or a sleek, modern look for a smart office environment, our Jigtech door handles are available in a range of shapes, styles and finishes.

Jigtech handles, latches and accessories are designed for internal use.



How it works

The system is based around a unique jig, which clamps to the door, auto aligning the drill holes on both the door face and the edge. Holesaws are used to accurately bore into the door, in preparation for the installation of the specially designed latches and door furniture.

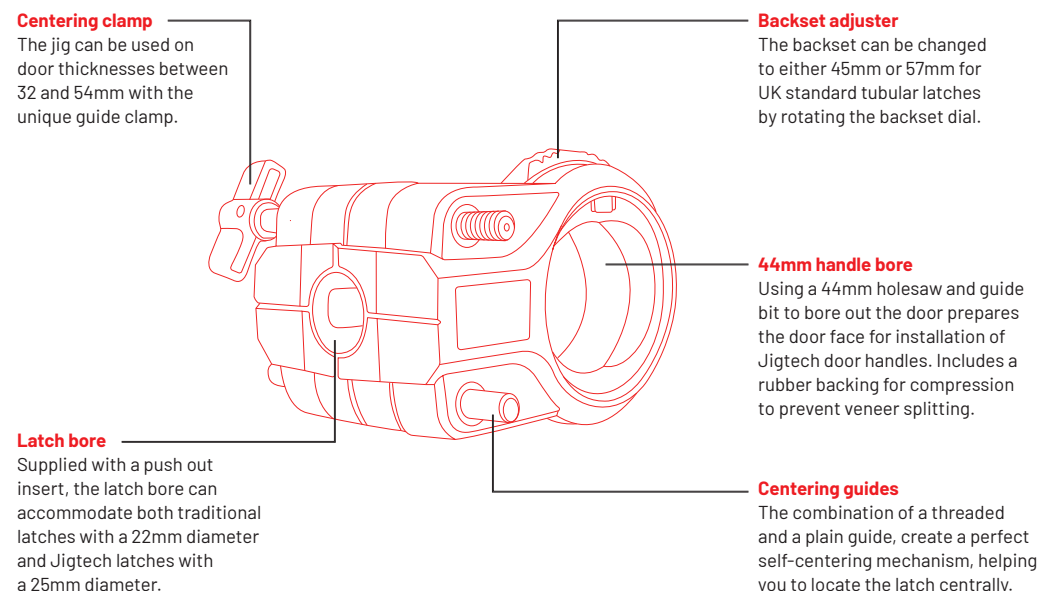

Jigtech PRO kit

Installation kit in carry case



What's included?

The Jigtech PRO installation kit is supplied in a robust carry case, containing the full range including: the jig, holesaws and arbors, spade bit and unique latch tappers and keep locators for the professional installer.

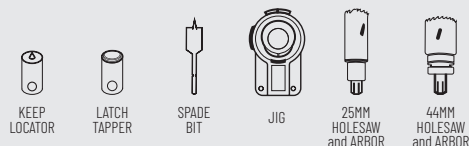

Description	Unit qty	Case qty	Product code
JIGTECH PRO kit	1	4	JTP6000

Useful icons

Dimensions

Lever on rose

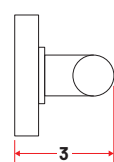
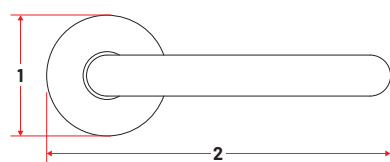

- 1 Handle - diameter of round rose or height/width of square rose
- 2 Handle length
- 3 Handle projection

Swatches

Our extensive collection of door hardware comes in a range of finishes to suit the needs of any door or project.

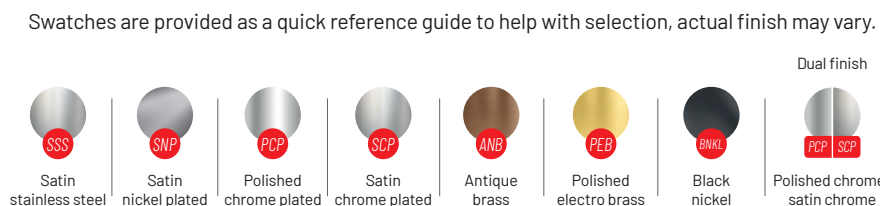

Icons and certifications

- All products in this brochure include fixings
- This handle is also available in a door pack



British designed

180 years of British engineering in Willenhall, the lock capital of Europe



Guarantees

Peace of mind with industry-leading product assurance

certifire

Certifire is a 3rd party approval scheme that confirms the product is suitable for use on fire doors. For details of actual approval see Certifire's website to view each certificate.



Fire door testing - fire resistance within door assemblies serves three main purposes: to restrict the initial development of the fire, to restrict the spread of the fire and to protect escape routes. Whenever fitting a latch to a fire door it must be fire door tested and fitted with an appropriate intumescent kit.

JIGTECH™



Jigtech slim rose handle coming soon in 2023

Stunning range of lever on rose handles

Sleek 3mm rose thickness

Exclusive new finishes

Perfect for commercial environments

Subtly enhance the look and feel of any internal door with Jigtech Premium fire-rated handles, which are quick and easy to install and legally compliant.

- Manufactured from premium zinc raw material
- Can be installed on fire doors up to FD60
- Certifire approved
- Compatible with Jigtech CE SmartLatch
- Suits 35-44mm door thickness
- 54mm fixing packs available

An extension fixing pack and 34mm spade bit will be required for doors of 54mm thickness and the handles must be installed with CE SmartLatch and an intumescent kit to be fully compliant for fire doors up to FD60.



Finishes

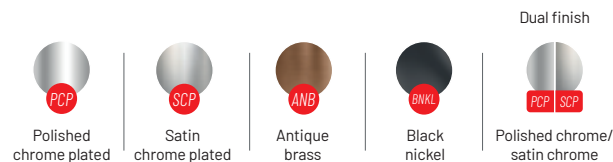

Condor

Lever on round rose



- To achieve the fire-rating, CE SmartLatch with intumescent kit must be used
- Intumescent kit and 34mm spade bit sold separately

Only compatible with Jigtech PRO kit

130mm 53mm

Boxed					
Description	Fire rated	Finish	Unit qty	Case qty	Product code
Condor fire rated lever on rose	FD30/FD60	PCP	1 set	20	JTF1020-F
Condor fire rated door pack	FD30/FD60	PCP	1	20	JTB71020-F
Condor privacy door pack	No	PCP	1	20	JTB81020

Condor

Lever on round rose

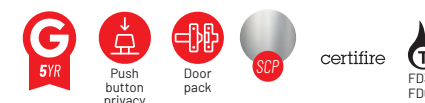

- To achieve the fire-rating, CE SmartLatch with intumescent kit must be used
- Intumescent kit and 34mm spade bit sold separately

Only compatible with Jigtech PRO kit

130mm 53mm

Boxed					
Description	Fire rated	Finish	Unit qty	Case qty	Product code
Condor fire rated lever on rose	FD30/FD60	SCP	1 set	20	JTF1220-F
Condor fire rated door pack	FD30/FD60	SCP	1	20	JTB71220-F
Condor privacy door pack	No	SCP	1	20	JTB81220

JIGTECH™



Fire-rated and Certifire approved handles

- Can be installed on fire doors up to FD60
- Easy to install and legally compliant
- Compatible with Jigtech CE SmartLatch

Eden

Lever on round rose



- To achieve the fire-rating, CE SmartLatch with intumescent kit must be used
- Intumescent kit and 34mm spade bit sold separately

Only compatible with Jigtech PRO kit

124mm 53mm

Boxed					
Description	Fire rated	Finish	Unit qty	Case qty	Product code
Eden fire rated lever on rose	FD30/FD60	PCP	1 set	20	JTF1015-F
Eden fire rated door pack	FD30/FD60	PCP	1	20	JTB71015-F
Eden privacy door pack	No	PCP	1	20	JTB81015

Eden

Lever on round rose



- To achieve the fire-rating, CE SmartLatch with intumescent kit must be used
- Intumescent kit and 34mm spade bit sold separately

Only compatible with Jigtech PRO kit

124mm 53mm

Boxed					
Description	Fire rated	Finish	Unit qty	Case qty	Product code
Eden fire rated lever on rose	FD30/FD60	SCP	1 set	20	JTF1215-F
Eden fire rated door pack	FD30/FD60	SCP	1	20	JTB71215-F
Eden privacy door pack	No	SCP	1	20	JTB81215

Harrier

Lever on round rose



- To achieve the fire-rating, CE SmartLatch with intumescent kit must be used
- Intumescent kit and 34mm spade bit sold separately

Only compatible with Jigtech PRO kit

122mm 56.5mm

Boxed					
Description	Fire rated	Finish	Unit qty	Case qty	Product code
Harrier fire rated lever on rose	FD30/FD60	PCP/SCP	1 set	20	JTF1070-F
Harrier fire rated door pack	FD30/FD60	PCP/SCP	1	20	JTB71070-F
Harrier privacy door pack	No	PCP/SCP	1	20	JTB81070

Sabre

Lever on round rose



- To achieve the fire-rating, CE SmartLatch with intumescent kit must be used
- Intumescent kit and 34mm spade bit sold separately

Only compatible with Jigtech PRO kit

119mm 56.5mm

Boxed					
Description	Fire rated	Finish	Unit qty	Case qty	Product code
Sabre fire rated lever on rose	FD30/FD60	PCP	1 set	20	JTF1005-F
Sabre fire rated door pack	FD30/FD60	PCP	1	20	JTB71005-F
Sabre privacy door pack	No	PCP	1	20	JTB81005

Sabre

Lever on round rose



- To achieve the fire-rating, CE SmartLatch with intumescent kit must be used
- Intumescent kit and 34mm spade bit sold separately

Only compatible with Jigtech PRO kit

119mm 56.5mm

Boxed					
Description	Fire rated	Finish	Unit qty	Case qty	Product code
Sabre fire rated lever on rose	FD30/FD60	SCP	1 set	20	JTF1205-F
Sabre fire rated door pack	FD30/FD60	SCP	1	20	JTB71205-F
Sabre privacy door pack	No	SCP	1	20	JTB81205

Solar

Lever on round rose

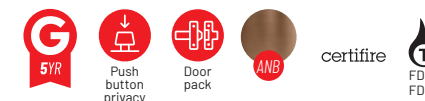

- To achieve the fire-rating, CE SmartLatch with intumescent kit must be used
- Intumescent kit and 34mm spade bit sold separately

Only compatible with Jigtech PRO kit

118mm 53.5mm

Boxed					
Description	Fire rated	Finish	Unit qty	Case qty	Product code
Solar fire rated lever on rose	FD60	ANB	1 set	20	JTF1600-F
Solar fire rated door pack	FD60	ANB	1	20	JTB71600-F
Solar privacy door pack	No	ANB	1	20	JTB81600

Solar

Lever on round rose



- To achieve the fire-rating, CE SmartLatch with intumescent kit must be used
- Intumescent kit and 34mm spade bit sold separately

Only compatible with Jigtech PRO kit

118mm 53.5mm

Boxed					
Description	Fire rated	Finish	Unit qty	Case qty	Product code
Solar fire rated lever on rose	FD30/FD60	SCP	1 set	20	JTF1200-F
Solar fire rated door pack	FD30/FD60	SCP	1	20	JTB71200-F
Solar privacy door pack	No	SCP	1	20	JTB81200

Solar

Lever on round rose



- To achieve the fire-rating, CE SmartLatch with intumescent kit must be used
- Intumescent kit and 34mm spade bit sold separately

Only compatible with Jigtech PRO kit

118mm 53.5mm

Boxed					
Description	Fire rated	Finish	Unit qty	Case qty	Product code
Solar fire rated lever on rose	FD30/FD60	PCP	1 set	20	JTF1000-F
Solar fire rated door pack	FD30/FD60	PCP	1	20	JTB71000-F
Solar privacy door pack	No	PCP	1	20	JTB81000

Solar

Lever on round rose



- To achieve the fire-rating, CE SmartLatch with intumescent kit must be used
- Intumescent kit and 34mm spade bit sold separately

Only compatible with Jigtech PRO kit

118mm 53.5mm

Boxed					
Description	Fire rated	Finish	Unit qty	Case qty	Product code
Solar fire rated lever on rose	FD30/FD60	BNKL	1 set	20	JTF1400-F
Solar fire rated door pack	FD30/FD60	BNKL	1	20	JTB71400-F
Solar privacy door pack	No	BNKL	1	20	JTB81400

Ultron

Lever on round rose



- To achieve the fire-rating, CE SmartLatch with intumescent kit must be used
- Intumescent kit and 34mm spade bit sold separately

Only compatible with Jigtech PRO kit

130mm 49mm

Boxed					
Description	Fire rated	Finish	Unit qty	Case qty	Product code
Ultron fire rated lever on rose	FD30/FD60	PCP/SCP	1 set	20	JTF1065-F
Ultron fire rated door pack	FD30/FD60	PCP/SCP	1	20	JTB71065-F
Ultron privacy door pack	No	PCP/SCP	1	20	JTB81065

Viper

Lever on round rose



- To achieve the fire-rating, CE SmartLatch with intumescent kit must be used
- Intumescent kit and 34mm spade bit sold separately

Only compatible with Jigtech PRO kit

115.5mm 61.5mm

Boxed					
Description	Fire rated	Finish	Unit qty	Case qty	Product code
Viper fire rated lever on rose	FD30/FD60	PCP	1 set	20	JTF1010-F
Viper fire rated door pack	FD30/FD60	PCP	1	20	JTB71010-F
Viper privacy door pack	No	PCP	1	20	JTB81010

Viper

Lever on round rose



- To achieve the fire-rating, CE SmartLatch with intumescent kit must be used
- Intumescent kit and 34mm spade bit sold separately

Only compatible with Jigtech PRO kit

115.5mm 61.5mm

Boxed					
Description	Fire rated	Finish	Unit qty	Case qty	Product code
Viper fire rated lever on rose	FD30/FD60	SCP	1 set	20	JTF1210-F
Viper fire rated door pack	FD30/FD60	SCP	1	20	JTB71210-F
Viper privacy door pack	No	SCP	1	20	JTB81210

Manufactured from a combination of zinc and aluminium alloy, our Contract range is strong and looks smart.

- No spindle cutting required
- Bolt through fitting as standard
- No wood screws required
- Can be converted to privacy function with accessory roses
- Available as push button privacy (sold separately)
- Factory assembled for fast fitting
- Suits 35-44mm door thickness
- 54mm fixing packs available
- Grub screw fixed rose

Finishes

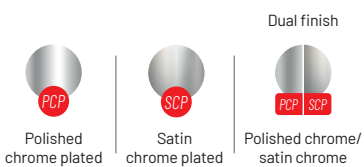

Cresta

Lever on round rose



Only compatible with Jigtech PRO kit

127.5mm 48mm

Description	Finish	Boxed		
		Unit qty	Case qty	Product code
Cresta lever on rose	PCP	1 set	20	JTC2000
Cresta passage door pack	PCP	1	20	JTB72000
Cresta privacy door pack	PCP	1	20	JTB82000

Cresta

Lever on round rose

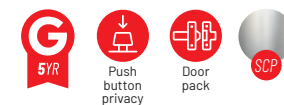

Only compatible with Jigtech PRO kit

127.5mm 48mm

Description	Finish	Boxed		
		Unit qty	Case qty	Product code
Cresta lever on rose	SCP	1 set	20	JTC2200
Cresta passage door pack	SCP	1	20	JTB72200
Cresta privacy door pack	SCP	1	20	JTB82200

JIGTECHPRO™



Easy to install

- Self-centering jig mechanism helps to locate the latch
- No spindle cutting or wood screws required
- Bolt through fitting as standard

Parma

Lever on round rose

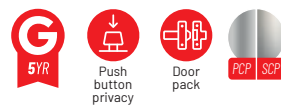

Only compatible with Jigtech PRO kit

127.5mm 48mm

Description	Finish	Unit qty	Case qty	Product code
Parma lever on rose	PCP/SCP	1 set	20	JTC2065
Parma passage door pack	PCP/SCP	1	20	JTB72065
Parma privacy door pack	PCP/SCP	1	20	JTB82065

Riva

Lever on round rose

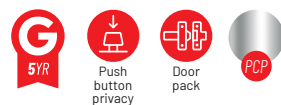

Only compatible with Jigtech PRO kit

115mm

Description	Finish	Unit qty	Case qty	Product code
Riva lever on rose	PCP	1 set	20	JTC2025
Riva passage door pack	PCP	1	20	JTB72025
Riva privacy door pack	PCP	1	20	JTB82025

Riva

Lever on round rose

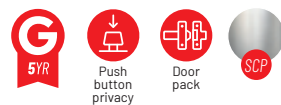

Only compatible with Jigtech PRO kit

115mm

Description	Finish	Unit qty	Case qty	Product code
Riva lever on rose	SCP	1 set	20	JTC2225
Riva passage door pack	SCP	1	20	JTB72225
Riva privacy door pack	SCP	1	20	JTB82225

Vecta

Lever on round rose

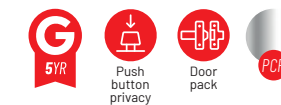

Only compatible with Jigtech PRO kit

125mm 60mm

Description	Finish	Unit qty	Case qty	Product code
Vecta lever on rose	PCP	1 set	20	JTC2020
Vecta passage door pack	PCP	1	20	JTB72020
Vecta privacy door pack	PCP	1	20	JTB82020

Venus

Door pack



Only compatible with Jigtech PRO kit

116.9mm

Description	Finish	Unit qty	Case qty	Product code
Venus passage door pack	PCP	1	20	JTB72051

Venus

Door pack



Only compatible with Jigtech PRO kit

116.9mm

Description	Finish	Unit qty	Case qty	Product code
Venus passage door pack	SCP	1	20	JTB72251

Quadra

Door pack



Only compatible with Jigtech PRO kit

123.5mm

Description	Finish	Boxed Unit qty	Case qty	Product code
Quadra passage door pack	PCP	1	20	JTB72005

Quadra

Door pack



Only compatible with Jigtech PRO kit

123.5mm

Description	Finish	Boxed Unit qty	Case qty	Product code
Quadra passage door pack	SCP	1	20	JTB72205

JIGTECH™



Saves time and money

Quicker installation of doors and handles on site
Increases earning potential of fitters
Pre-assembled handles

Kona

Door pack



Only compatible with Jigtech PRO kit

124.5mm 48.5mm

Description	Finish	Boxed Unit qty	Case qty	Product code
Kona passage door pack	PCP	1	20	JTB72010

Kona

Door pack



Only compatible with Jigtech PRO kit

124.5mm 48.5mm

Description	Finish	Boxed Unit qty	Case qty	Product code
Kona passage door pack	SCP	1	20	JTB82250

JIGTECHPRO™



Simple to use, accurate and precise

Unique self-centering clamp
Holesaws used to accurately bore the door
Grub screw fix rose



Switch handles simplify the installation process by utilising a bespoke spring-loaded plastic body with a stainless steel handle that just clicks into place.

The stainless steel switch handles are designed to suit commercial and office buildings and are available in passage style.

Finishes



Satin stainless steel

JIGTECHPRO™



Fit handles in under 5 minutes

Jigtech reduces fitting time from over 25 minutes as standard to under 5 minutes

Time saving of over 80% for installers

Factory assembled for fast fitting

Return to door lever



• Available in door pack only

Only compatible with Jigtech PRO kit

135mm 70.5mm

Description	Finish	Boxed Unit qty	Case qty	Product code
Return to door lever passage door pack	SSS	1	20	JTR7025

T-bar straight lever

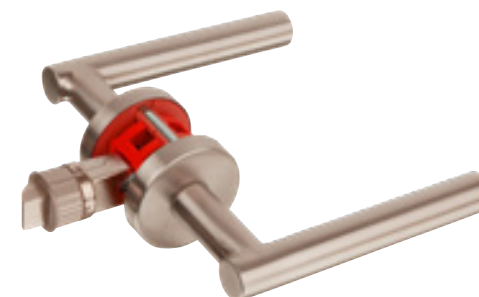

• Available in door pack only

Only compatible with Jigtech PRO kit

170mm 70.5mm

Description	Finish	Boxed Unit qty	Case qty	Product code
T-bar straight lever passage door pack	SSS	1	20	JTR7000

T-bar curved lever

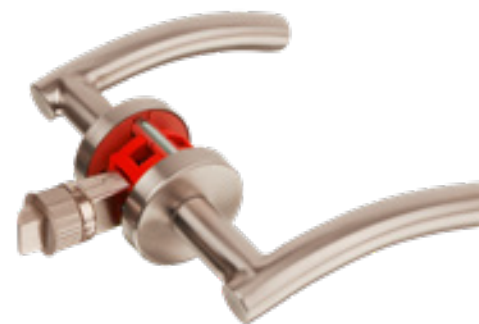

• Available in door pack only

Only compatible with Jigtech PRO kit

135mm 70.5mm

Description	Finish	Boxed Unit qty	Case qty	Product code
T-bar curved lever passage door pack	SSS	1	20	JTR7020



All Jigtech latches are supplied with spacers as standard and come in a range of finishes.

Every SmartLatch is supplied with both a round and rectangular strike plate and dust box.

Finishes



CE SmartLatch

Smart passage tubular latch



- Saves installer time in comparison to a rectangular faceplate
- Compatible with Jigtech premium fire rated handles
- More accurate, clean and precise install
- Can be used on both fire and non-fire-doors
- Supplied with square keep for retrofitting (NFR) and round keep for new installs (NFR and FR) - only round keep is fire rated
- Additional 34mm spade bit (JTA5003-F) is needed for install of circle keep
- To comply to FD30/FD60, an extended spindle, insert and intumescent is required

Backset: 45mm and 57mm

Description	Finish	Euro slot		57mm	
		Unit qty	Case qty	Product code	Product code
CE SmartLatch passage latch	PCP	1	5	JTL4021-F	JTL4020-F
CE SmartLatch passage latch	SNP	1	5	JTL4221-F	JTL4220-F
CE SmartLatch passage latch	BNKL	1	5	JTL4321-F	JTL4320-F
CE SmartLatch passage latch	PEB	1	5	JTL4421-F	JTL4420-F
CE SmartLatch passage latch	ANB	1	5	JTL4521-F	JTL4520-F

Privacy SmartLatch

Smart standard privacy latch



Supplied with both round and standard keep

Backset: 57mm

Description	Finish	Euro slot		57mm	
		Unit qty	Case qty	Product code	Product code
Smart standard privacy latch	PCP	1	5	JTL4022	JTL4022
Smart standard privacy latch	SNP	1	5	JTL4222	JTL4222
Smart standard privacy latch	BNKL	1	5	JTL4322	JTL4322
Smart standard privacy latch	PEB	1	5	JTL4422	JTL4422
Smart standard privacy latch	ANB	1	5	JTL4522	JTL4522

CE SmartBolt

Smart standard privacy latch



- Saves installer time in comparison to a rectangular faceplate
- Supplied with both round and standard keep - only round keep is fire rated

Backset: 57mm

Description	Finish	Euro slot		57mm	
		Unit qty	Case qty	Product code	Product code
CE SmartBolt	PCP	1	5	JTL4023-F	JTL4023-F
CE SmartBolt	SNP	1	5	JTL4223-F	JTL4223-F
CE SmartBolt	BNKL	1	5	JTL4323-F	JTL4323-F
CE SmartBolt	PEB	1	5	JTL4423-F	JTL4423-F
CE SmartBolt	ANB	1	5	JTL4523-F	JTL4523-F

Accessories

Required to comply to FD30/FD60 with CE SmartLatch



Description	Fire rating		Euro slot	
	FD30	FD60	Unit qty	Product code
Extended spindle	-	Y	1	JTA0060-F
Extended insert	-	Y	1	JTA0061-F
34mm spade bit	Y	Y	1	JTA5003-F
Intumescent	Y	Y	1	JTA3060-IK



Jigtech accessories feature two product ranges: replacement tools for installation and door furniture accessories for push button privacy latches and bathroom turns.

Finishes

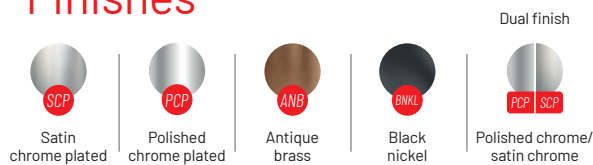

Round privacy rose cover



- Converts passage to privacy function
- Compatible with Jigtech privacy latches

Only compatible with Jigtech PRO kit

Description	Euro slot			
	Finish	Unit qty	Case qty	Product code
Round privacy rose cover	PCP	1	5	JTA5200
Round privacy rose cover	SCP	1	5	JTA5201
Round privacy rose cover	BNKL	1	5	JTA5203
Round privacy rose cover	ANB	1	5	JTA5205

Square passage rose cover



- Supplied as a pair

Only compatible with Jigtech PRO kit

Description	Euro slot			
	Finish	Unit qty	Case qty	Product code
Square passage rose cover	PCP	1	5	JTA5300
Square passage rose cover	SCP	1	5	JTA5301
Square passage rose cover	BNKL	1	5	JTA5303
Square passage rose cover	ANB	1	5	JTA5305

Square privacy rose cover



- Converts passage to privacy function
- Compatible with Jigtech privacy latches

Only compatible with Jigtech PRO kit

Description	Euro slot			
	Finish	Unit qty	Case qty	Product code
Square privacy rose cover	PCP	1	5	JTA5400
Square privacy rose cover	SCP	1	5	JTA5401
Square privacy rose cover	BNKL	1	5	JTA5404
Square privacy rose cover	ANB	1	5	JTA5405

Round bathroom turn and release



- Suits 35-44mm door thickness
- Supplied with 5mm spindles
- 54mm fixing packs available

Only compatible with Jigtech PRO kit

Description	Euro slot			
	Finish	Unit qty	Case qty	Product code
Round bathroom turn and release set	PCP	1	5	JTA5500
Round bathroom turn and release set	SCP	1	5	JTA5501
Round bathroom turn and release set	BNKL	1	5	JTA5503
Round bathroom turn and release set	ANB	1	5	JTA5505
Round bathroom turn and release set	PCP/SCP	1	5	JTA5510

Square bathroom turn and release



- Suits 35-44mm door thickness
- Supplied with 5mm spindles
- 54mm fixing packs available

Only compatible with Jigtech PRO kit

Description	Euro slot			
	Finish	Unit qty	Case qty	Product code
Square bathroom turn and release set	PCP	1	5	JTA5600
Square bathroom turn and release set	SCP	1	5	JTA5601
Square bathroom turn and release set	BNKL	1	5	JTA5603
Square bathroom turn and release set	ANB	1	5	JTA5605

Holesaw and arbor set



- For use with the Jigtech system

Only compatible with Jigtech PRO kit

Description	Euro slot		
	Unit qty	Case qty	Product code
25mm holesaw only	1	5	JTA5001
25mm holesaw and arbor set	1	5	JTA5010
44mm holesaw only	1	5	JTA5002
44mm holesaw and arbor set	1	5	JTA5011

Spade bit



- Pre-marked depth gauge for accurate drilling

Only compatible with Jigtech PRO kit

Description	Euro slot		
	Unit qty	Case qty	Product code
32mm spade bit (standard install)	1	5	JTA5003
34mm spade bit (to be used with fire doors due to intumescent)	1	5	JTA5003-F

Keep locator and latch tapper



- Protects latch from accidental damage during installation
- Designed to align the keep to the latch bolt

Only compatible with Jigtech PRO kit

Description	Euro slot		
	Unit qty	Case qty	Product code
Keep locator and latch tapper	1	5	JTA5103



We can come to you and set up a live demonstration of Jigtech at your branch. This can help bring the many benefits of our Jigtech range to life for your customers.

Email us to book yours on csdcomm@assaabloy.com

UNION

ASSA ABLOY



0845 223 2124



uniononline.co.uk

JIG TECH™



Every effort has been made to ensure the accuracy of product information at time of publication in November 2022. We are continually developing our products and reserve the right to change the specification of the products within this catalogue with or without prior notice. Subject to our Terms and Conditions of trading, a copy of our T's and C's is available upon request. For further help or information, please visit uniononline.co.uk or call our customer service team.

Performance you can trust